

VÁLVULA RETENÇÃO DUPLA PORTINHOLA 150 LBS – FIG: 160

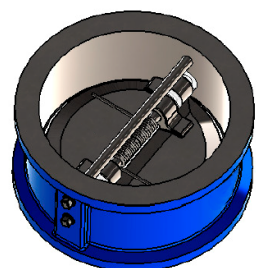

1 - CORPO
FºFº NOD. ASTM A536 GR. 65-45- BRONZE INDUSTRIAL ASTM B-62-09
BRONZE ALUMÍNIO ASTM B148
AÇO CARBONO ASTM A216 GR.
AÇO INOX ASTM A351 GR. CF8 REV.
AÇO INOX ASTM A351 GR. CF8M

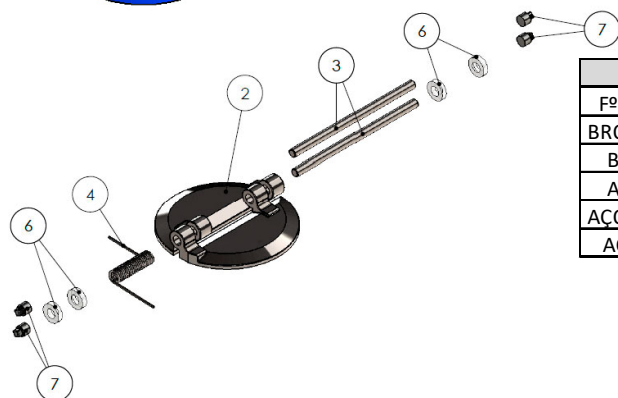

2 - FLAP PORTINHOLA
FºFº NOD. ASTM A536 GR. 65-45- BRONZE INDUSTRIAL ASTM B-62-09
BRONZE ALUMÍNIO ASTM B148
AÇO CARBONO ASTM A216 GR.
AÇO INOX ASTM A351 GR. CF8 REV.
AÇO INOX ASTM A351 GR. CF8M

3 - EIXO
AÇO INOX AISI 410 - ASTM
AÇO INOX AISI 304 - ASTM
AÇO INOX AISI 316 - ASTM

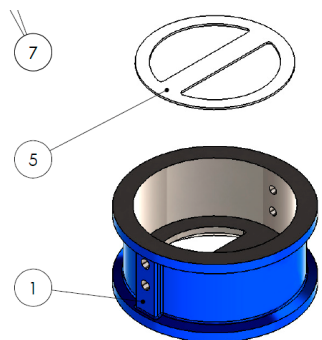

4 - MOLLA
AÇO INOX AISI
AÇO INOX AISI
AÇO INOX AISI
INCONEL X-750

5 - VEDAÇÃO
EPDM
BUNA-N
VITON
NEOPRENE
SILICONE
HYPALON
SBR
PTFE
METAL / METAL

6 - BUCHA
NYLON

7 - PLUG
AÇO GALVANIZADO

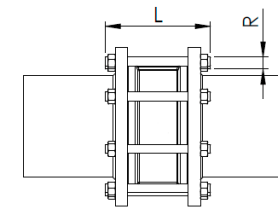
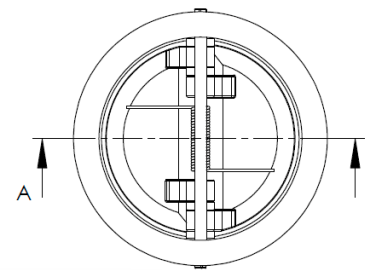
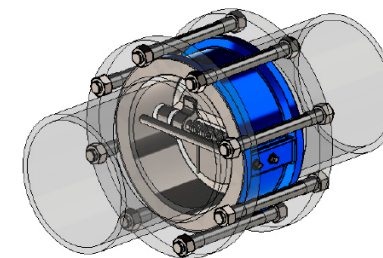
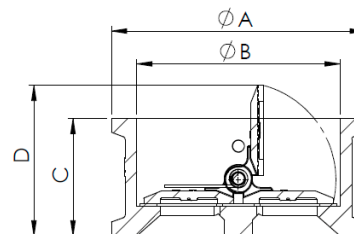

DN	A	B	C	D	R	L	
						PARAFUSO	PRISIONEIRO
1½"	82	54	60	52	W 1/2"	117	130
2"	106	60	60	55	W 5/8"	130	136
2½"	125	75	67	65	W 5/8"	143	150
3"	137	90	73	73	W 5/8"	149	162
4"	170	120	73	90	W 5/8"	149	162
5"	194	140	86	105	W 3/4"	170	181
6"	220	169	98	126	W 3/4"	170	181
8"	275	219	127	170	W 3/4"	216	230
10"	332	272	146	205	W 7/8"	241	260
12"	400	324	181	245	W 7/8"	283	296
14"	442	365	184	275	W 1"	292	311
16"	495	415	190	315	W 1"	305	324
18"	540	465	203	340	W 1.¼"	324	349
20"	595	512	219	370	W 1.¼"	353	372
24"	718	615	222	415	W 1.¼"	368	394
28"	803	700	305	480	W 1.¼"	498	525
30"	878	764	305	510	W 1.¼"	505	532
32"	909	820	326	550	W 1.½"	550	580
36"	1010	900	368	610	W 1.½"	610	640